



COWAY LOVES THE PLANET
This paper can be recycled.

COWAY

Water Purifier CHP/CP-6310L

- This product cannot be used if the voltage is different from that mentioned in the rating plate.
- For your safety and proper use of the product, please read this User's Manual before use.

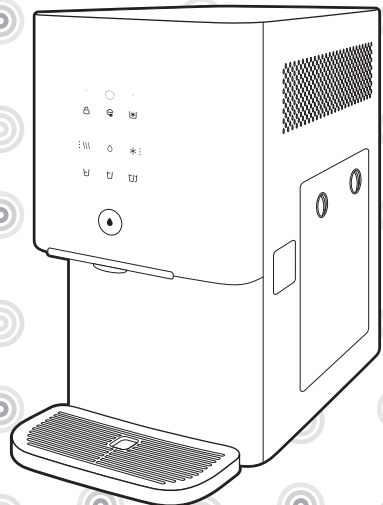

FEATURES

1

Convenient quantitative dispensing for hot(CHP-6310L), cold and ambient water.

This convenient feature automatically extracts the exact amount of water (ambient, cold or hot(CHP-6310L)) you wish through a single faucet.



2

Cold Water Plus feature

With this feature, a more abundant supply of cold water can be provided as this model uses separate cold and ambient water tanks.



3

Energy saving light sensor

When in ECO mode, the device automatically reduces the frequency of motor and heater operation to reduce power consumption.



4

Slim size and a refined design

This device can be conveniently installed and used in any kitchen, no matter how small, with its slim size and elegant design.



DEAR CUSTOMERS

Thank you for using **Coway Water Purifier**

Please read this User Manual to learn about proper usage and maintenance of the product.

When a problem occurs while using the product, it can be solved by referring to the instructions in this manual.

CONTENTS

Product Information

- | 03 | Safety Information
- | 07 | Parts Name
- | 08 | Water Purification Process

How to use

- | 09 | Please Check Before Use
- | 10 | How to Use Hygienically
- | 11 | Buttons and Indicators
- | 19 | How to Get the Desired Water
 - How to Get Cold Water
 - How to Get Ambient Water
 - How to Get Hot Water (CHP-6310L)

Maintenance

- | 21 | How to Install
- | 23 | How to Clean
 - How to Clean Internal Water Tank
 - How to Clean the Tray
 - How to Clean Water Purifier
 - How to Clean Transparent Faucet Cover
- | 27 | Filter Replacement
- | 28 | How to Replace the Filter
- | 30 | Regular Maintenance

Others

- | 31 | Troubleshooting
- | 32 | Specification
- | 33 | Water Flow Diagram
- | 34 | Performance Data Sheet

- Please keep the user manual in easily accessible areas. -

SAFETY INFORMATION

▲ DANGER : Indicates an imminently hazardous situation which if not avoided, will result in death or serious injury.

- Do not use damaged power plugs or loose sockets.
- Do not pull on the power cord.
- Do not pull on the power cord to move the product.
- Do not touch the power plug with wet hands.
- Do not bend the power cord excessively or put it under a heavy object to avoid damage or deformation.
- Do not plug and unplug the power cord repeatedly.
- When the power area comes into contact with water, unplug the power plug and completely dry it prior to use.
- Make sure to unplug the power cord when repairing, inspecting the product or changing its parts.
- Completely wipe off dust, water etc. on the power plug's pins and areas of contact with the pins.
- Do not connect multiple products to one power outlet. Use a separate socket for the product.
- Lock the tap water supply valve and disconnect power when not using the product for an extended period of time.
- Do not modify the power cord on your own.
- If the power cord is damaged, do not attempt to replace the cord. Instead, contact the service center to replace it.
- Do not install near sources of heat.
- Connect the tap water to the cold water tubing.

-
- Please lock the tap water valve and disconnect the power plug and contact the service center if there is water leakage from inside the product or if water is puddling around the product.
 - Immediately disconnect the power plug and contact the service center if there is any burning smell or smoke or strange noises from the product.
 - Do not put candles, lighters, etc. on top of this product.
 - Do not put bowls of water, chemicals, food, small metal objects, or flammable materials on top of this product.
 - Disconnect the power plug prior to cleaning.
 - Do not arbitrarily open, repair or remodel the product.

▲ THIS APPLIANCE CAN BE USED BY CHILDREN AGED FROM 8 YEARS AND ABOVE AND PERSONS WITH REDUCED PHYSICAL, SENSORY OR MENTAL CAPABILITIES OR LACK OF EXPERIENCE AND KNOWLEDGE IF THEY HAVE BEEN GIVEN SUPERVISION OR INSTRUCTION CONCERNING USE OF THE APPLIANCE IN A SAFE WAY AND UNDERSTAND THE HAZARDS INVOLVED.

▲ CHILDREN SHALL NOT PLAY WITH THE APPLIANCE.

▲ CLEANING AND USER MAINTENANCE SHALL NOT BE MADE BY CHILDREN WITHOUT SUPERVISION.

SAFETY INFORMATION

▲ WARNING : Indicates a potentially hazardous situation which, if not avoided, could result in death or serious injury.

- Do not apply excessive force or impact to the product.
- Do not install the product on a tilted surface. Do not apply excessive force or impact to the product.
- Do not install in a location with too much humidity or dust or in a location exposed to water or rain.
- Do not directly spray water on the product for cleaning or use benzene or thinner to wipe the product.
- As the refrigerant used in this product is isobutane (R-600a), which is a combustible natural gas, ensure that the product is not damaged while moving it.
- If the refrigerant leaks from the internal piping, a fire or injury may occur.
- Move away all flammable objects or object that ignite sparks, and then ventilate the area.
- The refrigerant used in this product is isobutane (R-600a), a combustible natural gas. For your safety, contact your local community center before throwing away to safely dispose of this product.
- Do not damage pipes, etc. while disposing of this product.

⚠ CAUTION : Indicates a potentially hazardous situation which, if not avoided, may result in minor or moderate injury or damage to the product or other properties.

- Use tap water as source water.
 - ① Use tap water that is suitable for drinking as source water.
 - ② Do not use in wet places such as bathroom.
 - ③ Do not use in places of high humidity or temperature.
- Drain the stored water as well as newly filtered water one more time completely prior to use when not using the product for an extended period of time.
- Do not come into close contact with hot water as it is very hot and scalding may occur.
- Please replace the filter according to the filter replacement cycle for clean water.
- People with physical, sensory, or mental impairment as well as children must be supervised or guided while using the water purifier.
- You must use the new hose set provided with this product. Do not reuse old hose sets.
- This appliance can be used by children aged from 8 years and above and persons with reduced physical, sensory or mental capabilities or lack of experience and knowledge if they have been given supervision or instruction concerning use of the appliance in a safe way and understand the hazards involved.
- Children are not to play with the product.
- Cleaning and user maintenance shall not be made by children without supervision.

READ AND SAVE THESE INSTRUCTIONS

PARTS NAME

Front

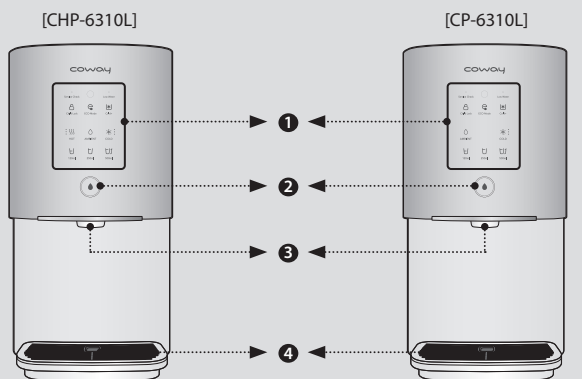

① Controls/Display ② Dispenser buttons ③ Faucet ④ Tray

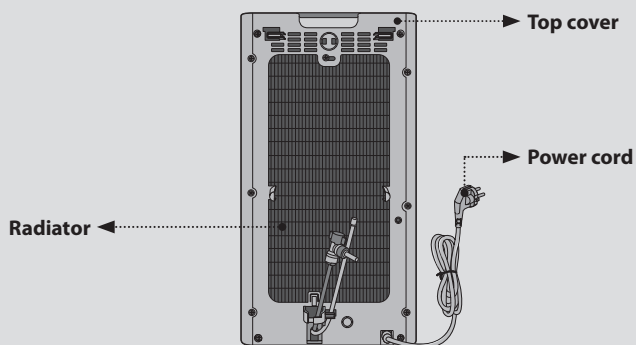

Accessories



User's manual



Drain hose



Fitting clip

WATER PURIFICATION PROCESSES

The essence of the water purification system lies in the filters.
Using an uncertified filter; or even using a certified yet expired filter may reduce filter performance.

4-Step Water Purification System (CHP/CP-6310L)

Step 1, 2 : Neo-Sense filter

This Neo-Sense filter has the function of removing particulates, dissolved organic and inorganic impurities. It also has another function to remove chlorine, volatile organic compounds (VOC's).

Step 3 : Membrane filter (RO)

RO Membrane filter has a function to remove water contaminants such as heavy metals, waterborne microorganisms and harmful organic chemicals etc.
The water which contains harmful materials is eliminated through the reject water hose as disposed water.

Step 4 : Plus Inno-Sense filter

This Plus Inno-Sense filter has functions to remove smell inducing material and to improve the taste of water.

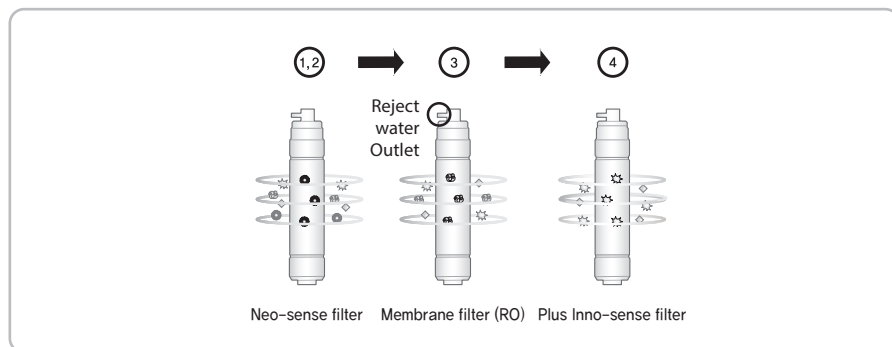

Tips

Uses of the disposed water

- The disposed water should be used only for cleaning the house, clothes, or purposes other than drinking.
- Never use the disposed water for drinking or for cooking.

PLEASE CHECK BEFORE USE

Please check before use

⚠ This product is for 220 V - 240 V~, 50 Hz.

Make sure to connect the power plug to a grounded 220 V - 240 V~, 50 Hz outlet. It requires a power supply to operate.

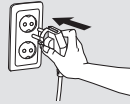

■ Open the tap water supply valve

The water purifier can work properly only when the tap water is supplied.

■ When indicator light on the display is turned off

When the indicator light is off, check if there is a blackout or if the power supply is cut off for other reasons.

■ When the product has not been used for a long time

Completely drain the stored water as well as newly filtered water one more time prior to use when using the product after an extended period of time.

■ After installation

After installation, filter and drain water for at least 130 minutes (Use after draining purified water at least twice).

■ Regular filter replacement

Regular filter replacement is crucial for clean drinking water. Using expired filters decreases water purifier performance, so please replace the filters on time.

■ How to drain hot water

Press the drain cover on the side of the device, then insert the drain hose (continuous dispensing hose) to drain hot water from inside the hot water tank (Be careful not to be burned while draining hot water).



Turn off the tap water valve and unplug the power cord when not using the water purifier for a long time.

HOW TO USE HYGIENICALLY

Category	Type	Details
Period of use	When not used for a long time	<ul style="list-style-type: none"> Refer to "Cleaning" in the instruction manual for instructions on interior cleaning and storage. When using after long-term storage, clean before reuse.
How to Use	Faucet Contamination	<ul style="list-style-type: none"> Do not touch the faucet area with your hands, mouth, or cups you have used. Self-care - Wipe the faucet with a clean, dry rag/non-woven fabric, etc. (wipe once per week).
	When getting water	<ul style="list-style-type: none"> Be careful that drinks (coffee, tea, carbonated beverages) and food don't splash into the faucet or onto the front cover. If there are drinks or other foreign matter on the device, wipe immediately to prevent further contamination.
	Tray and filtered water tank	<ul style="list-style-type: none"> Do not throw in coffee, drinks, food, or anything other than leftover water. Do not leave water in the tray for more than one day. Clean these parts yourself once per week.
	Product disassembly	<ul style="list-style-type: none"> Do not disassemble or open the device at your discretion.
	Product use	<ul style="list-style-type: none"> Do not put anything on top of the device (there may be contamination).
Hardware	Filter	<ul style="list-style-type: none"> Do not install or use filters other than genuine Coway filters.
Maintenance	Checkups	<ul style="list-style-type: none"> Have your device serviced once every 2 months. * Maintenance period may differ by product.
	Filter replacement cycle	<ul style="list-style-type: none"> Have filters replaced and checked according to the replacement cycle set for each filter.
	Maintenance personnel	<ul style="list-style-type: none"> Have your Coway device serviced by a Coway Cody or Coway Technician. If part replacement or interior cleaning are done by someone without expertise, there is a risk of leakage, etc. Request a Coway Cody or Coway Technician.
	Maintenance card record	<ul style="list-style-type: none"> If checkup/cleaning/part replacement was done during servicing, check that this information has been recorded on the maintenance card.
	Surroundings	<ul style="list-style-type: none"> Keep the device surroundings clean (trash can, etc.) so it stays in a hygienic environment.
Installation	Product disassembly and installation	<ul style="list-style-type: none"> Do not install or disassemble the device at your own discretion; have a Coway Technician do it.
	Installation environment	<ul style="list-style-type: none"> Do not install the device where it may easily be contaminated. - Unhygienic places such as inside bathrooms, places with a lot of mice or insects (ants, cockroaches, etc.), and ships; near severely contaminated places like easily contaminated rivers, livestock or waste water, etc. - Seawater areas with a lot of humidity or salinity - Places that receive direct sunlight - Other unhygienic places considered unsuitable for device installation

BUTTONS AND INDICATORS (CHP-6310L)

Indicators

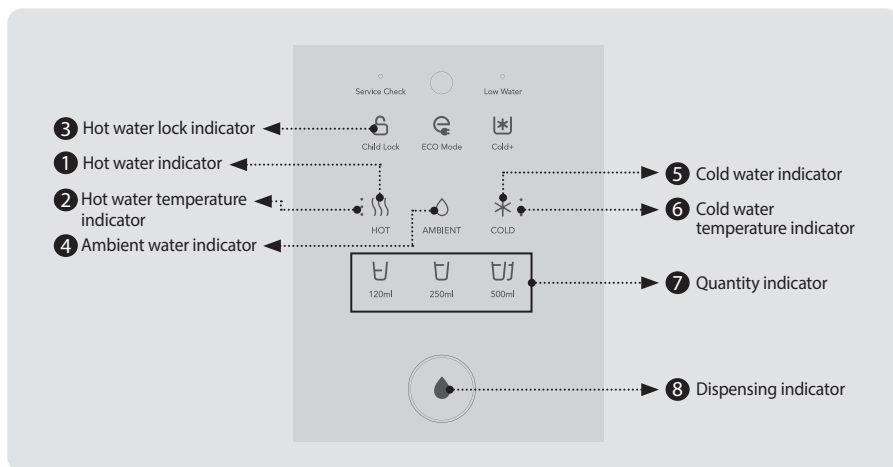

1 Hot water indicator

The indicator lights up when hot water is selected.



2 Hot water temperature indicator

The indicator lights up according to the temperature of the hot water. The temperature of the hot water is at its highest when all 3 LED lights are illuminated.



3 Hot water lock indicator

The indicator lights up when hot water lock is selected.



4 Ambient water indicator

The indicator lights up when ambient water is selected.



5 Cold water indicator

The indicator lights up when cold water is selected.



6 Cold water temperature indicator

The indicator lights up according to the temperature of the cold water. The temperature of cold water is at its lowest when all 3 LED lights are illuminated.



7 Quantity indicator

Shows how much water is selected to dispense.

☺ (Half cup-about 120 ml) :

A good amount of water to use for coffee or tea

☺☺ (One cup-about 250 ml) :

A perfect amount of water to drink

☺☺☺ (Two cups-about 500 ml) :

A good amount of water to use to cook ramen, etc.



8 Dispensing indicator

This indicator lights up when water is being extracted.

Indicators

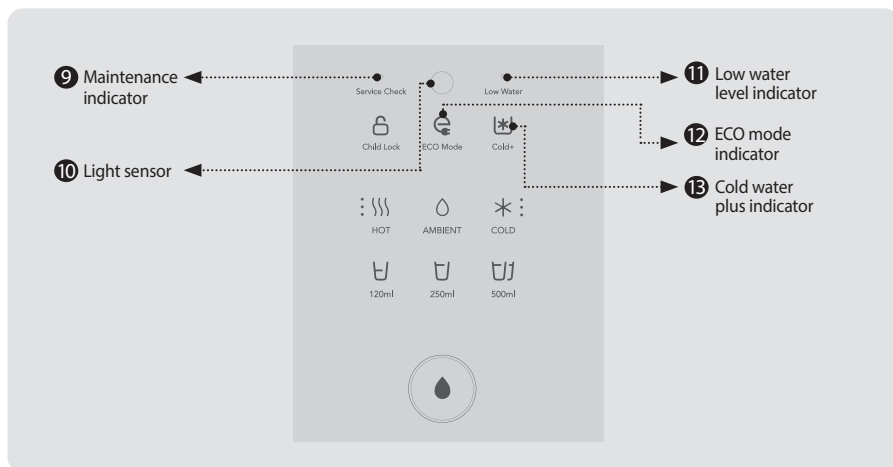

Service Check

9 Maintenance indicator

This indicator lights up when maintenance service is required.

**10 Light sensor**

This sensor detects light around the device to discern whether it is day or night.



Low Water

11 Low water level indicator

The indicator will light up when the water level in the tank is low.



ECO Mode

12 ECO mode indicator

The indicator lights up when the ECO mode feature is on.



Cold+

13 Cold water plus indicator

The indicator lights up when the cold water plus feature is selected.

BUTTONS AND INDICATORS (CHP-6310L)

Buttons

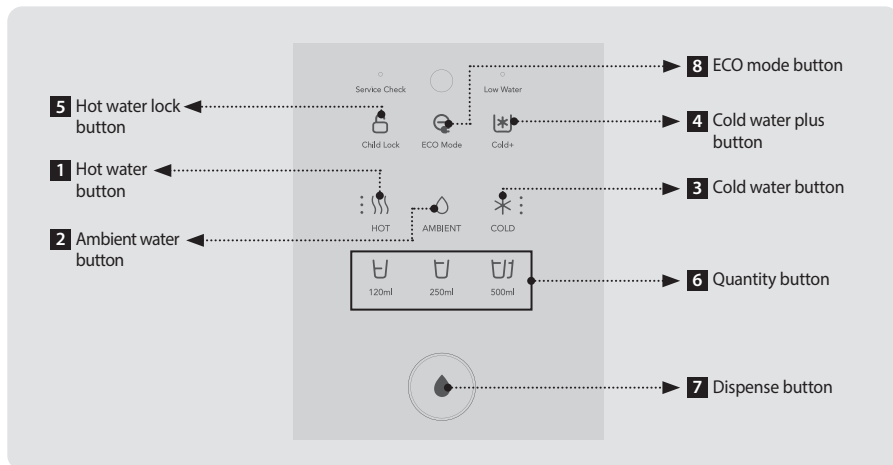

1 Hot water button

Use when you wish to extract hot water.



2 Ambient water button

Use when you wish to extract ambient water.



3 Cold water button

Use when you wish to extract cold water.



4 Cold water plus button

Use when you want to turn on the cold water plus feature.



5 Hot water lock button

Use when turning on hot water lock. hold for about 2 seconds to turn hot water lock on/off.
(You cannot select/dispense hot water while hot water lock is active.)



6 Quantity button

Use when selecting the amount of water you wish to extract.



7 Dispense button

Use when you wish to extract water.



8 ECO mode button

Use when you want to turn ECO mode on.

BUTTONS AND INDICATORS (CP-6310L)

Indicators

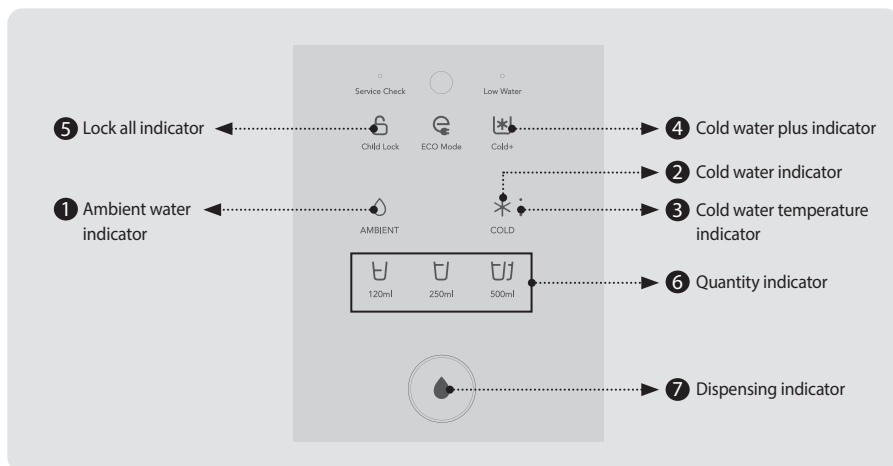

1 Ambient water indicator

The indicator lights up when ambient water is selected.



2 Cold water indicator

The indicator lights up when cold water is selected.



3 Cold water temperature indicator

The indicator lights up according to the temperature of the cold water. The temperature of cold water is at its lowest when all 3 LED lights are illuminated.



4 Cold water plus indicator

The indicator lights up when the cold water plus feature is selected.



5 Lock all indicator

The indicator lights up when lock all is selected.



6 Quantity indicator

Shows how much water is selected to dispense.

☒ (Half cup-about 120 ml):
A good amount of water to use for coffee or tea

☒ (One cup-about 250 ml):
A perfect amount of water to drink

☒ (Two cups-about 500 ml):
A good amount of water to use to cook ramen, etc.



7 Dispensing indicator

This indicator lights up when water is being extracted.

BUTTONS AND INDICATORS (CP-6310L)

Indicators

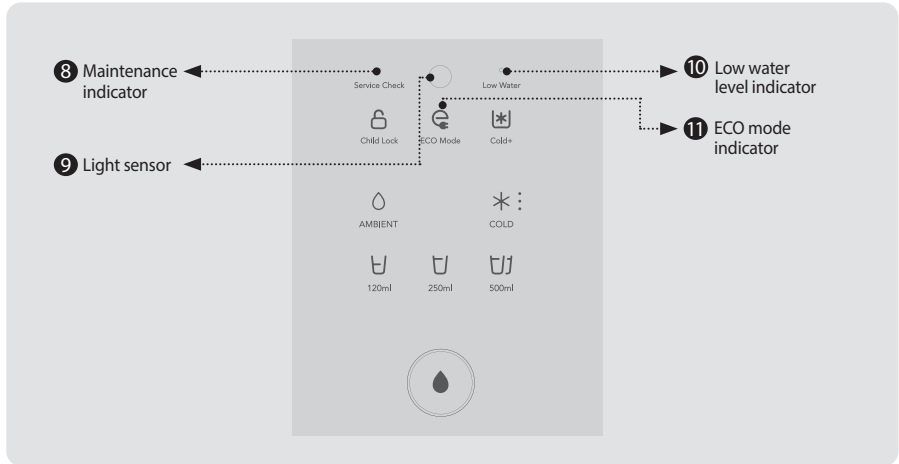

8 Maintenance indicator

This indicator lights up when maintenance service is required.



9 Light sensor

This sensor detects light around the device to discern whether it is day or night.



10 Low water level indicator

The indicator will light up when the water level in the tank is low.



11 ECO mode indicator

The indicator lights up when the ECO mode feature is on.

Buttons

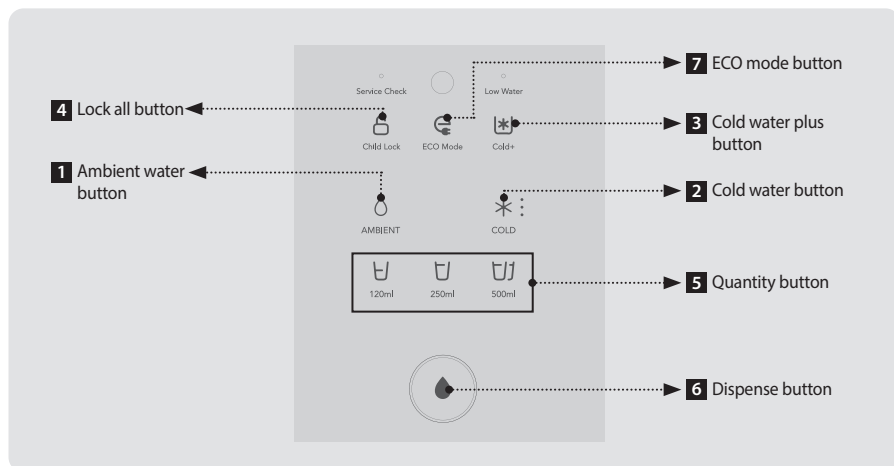
**1 Ambient water button**

Use when you wish to extract ambient water.

**2 Cold water button**

Use when you wish to extract cold water.

**3 Cold water plus button**

Use when you want to turn on the cold water plus feature.

**4 Lock all button**

Use this to turn the lock all feature on/off (press and hold).

**5 Quantity button**

Use when selecting the amount of water you wish to extract.

**6 Dispense button**

Use when you wish to extract water.

**7 ECO mode button**

Use when you want to turn ECO mode on.

BUTTONS AND INDICATORS

■ To use the hot water feature(CHP-6310L)

Press the hot water button for at least 2 seconds and check to see whether the display shows the hot water feature on and whether the hot water temperature indicator is lit. To turn off hot water, press and hold the hot water button again for at least 5 seconds.

- * You can get hot water about 30 minutes after you turn on the hot water feature.

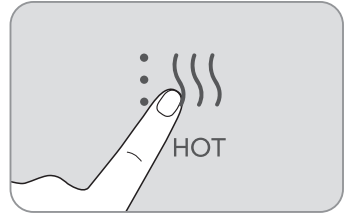

■ To use the cold water feature

Press the cold water button for at least 2 seconds and check to see whether the display shows the cold water feature on and whether the cold water temperature indicator is lit. To turn off cold water, press and hold the cold water button again for at least 5 seconds.

- * You can get cold water starting about two hours after you turn on the cold water feature.

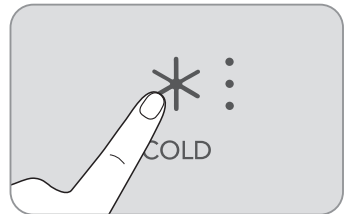

■ To use the cold water plus feature

Press the Cold water plus button for at least 2 seconds and check to see whether the display shows the Cold Water Plus feature on and whether the cold water plus indicator is lit. To turn off cold water plus, press and hold the cold water plus button again for at least 2 seconds.

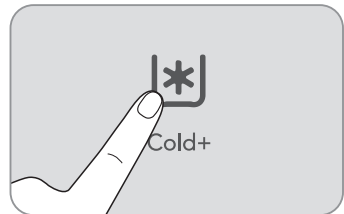

Tips

- Cold water plus is useful if you want to get a lot of cold water at once.
(Using Cold Water Plus feature frequently does not affect on you relectricity fees.)

■ To use the ECO mode feature

Press and hold the ECO mode button for at least 2 seconds to turn ECO mode on. The ECO mode indicator blinks when the product recognizes night.

* If the ECO mode indicator is on, the cold water temperature is kept relatively high when the area around is dark.

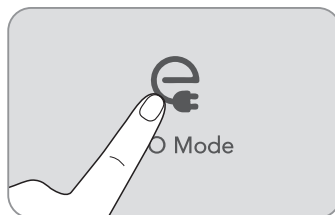

Tips

- If the water purifier does not dispense cold water, check to see whether the cold water indicator is lit (see page 11).
- When the level of room-temperature water inside the water tank is low, you may not be able to get as much water as usual.
- When the power cord is reconnected or there is a blackout, the last settings used are kept.
- This product has a ECO mode feature when not in use. If not used for a long time (approximately 9 hours), the hot water (CHP-6310L) temperature is automatically decreased and the cold water temperature kept higher to help save on electricity costs. When ECO mode is on due to non-use, the hot water (CHP-6310L) may be less hot and the cold water may be somewhat less cold.

HOW TO GET THE DESIRED WATER

How to Get Cold Water

Check the cold water temperature indicator and touch the cold water button, and then touch the quantity button to set the amount of water you want. Press the dispense button to get your selected amount of cold water. Press the dispense button again while dispensing to stop the water. To continuously get cold water, press and hold for at least 3 seconds. You will get a stream of cold water for about 3 minutes. Press the dispense button again while dispensing to stop the water.

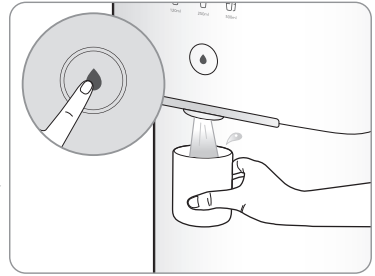
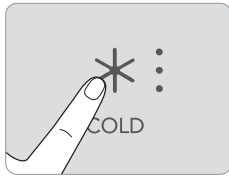

Tips

- If cold water is not dispensed from the water purifier, check that the cold water indicator is lit up on the display(see p. 11).
- If water is not dispensed from the water purifier, check whether the low water level indicator is lit up on the display(see p. 12)

How to Get Ambient Water

Touch the ambient water button, and then touch the quantity button to set the amount of water you want. Press the dispense button to get your selected amount of ambient water. Press the dispense button again while dispensing to stop the water. To continuously get ambient water, press and hold for at least 3 seconds. You will get a stream of water for about 3 minutes. Press the dispense button again while dispensing to stop the water.



Tips

- If ambient water is not dispensed from the water purifier, check whether the low water level indicator is lit up on the display(see p. 12).

How to Get Hot Water

Touch the hot water button, and then touch the quantity button to set the amount of water you want. Press the dispense button to get your selected amount of hot water. Press the dispense button again while dispensing to stop the water. To continuously get hot water, press and hold for at least 3 seconds. You will get a stream of water for about 3 minutes. Press the dispense button again while dispensing to stop the water.



Tips

- If water is not dispensed from the water purifier, check whether the low water level indicator is lit up on the display(see p. 12).
- Be careful not to get burned when using hot water.

HOW TO INSTALL

Installation Guide

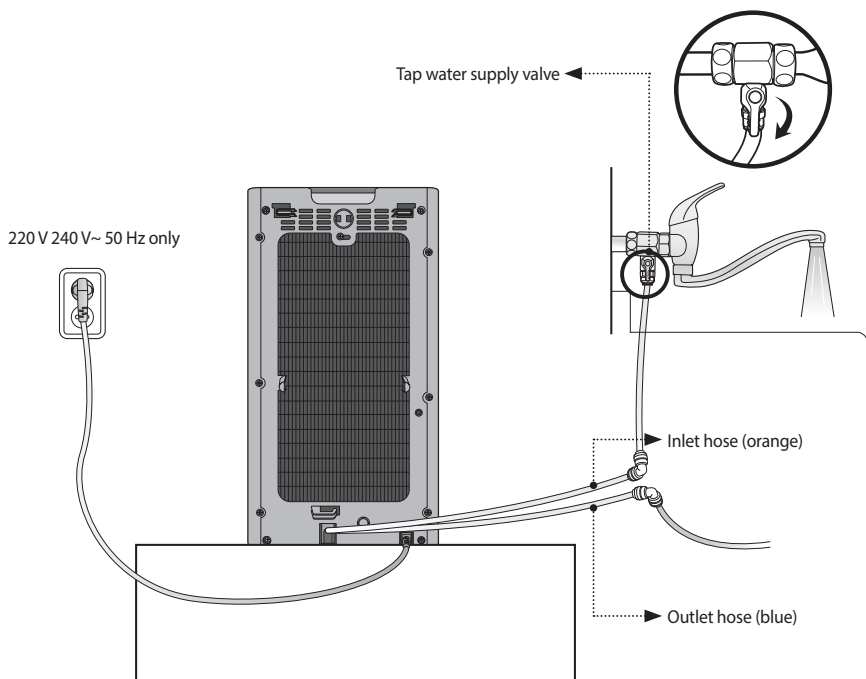

Connect the orange inlet hose **1** to the water pipe.
Connect the leftover water outlet hose **2**.

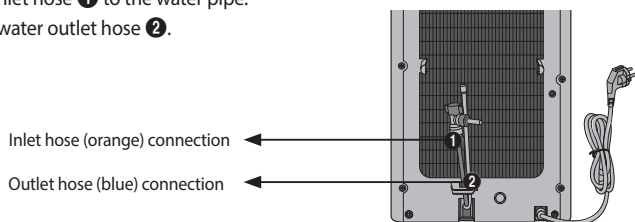

Caution

⚠ Where to install I

Avoid installing the water purifier in an area with uneven surface, extreme humidity, extreme light exposure, extreme dust exposure, and water exposure etc.

⚠ Where to install II

Keep the radiator grill at the rear of the product at least 10 cm away from the wall and make sure that the installation floor is firm.

⚠ Relocation and installation

When moving between locations, wait at least 30 minutes after installation to connect the power.

⚠ Cold water tubing

Make sure to connect it to the cold water tubing (If connected to the hot water tubing, the filters can get damaged).

⚠ After installation

After installation, filter and drain water for at least 130 minutes
(Use after draining purified water at least twice).



Tips

- Please consult a Coway installation technician for detailed instructions on installation for optimal product performance.
- Service inquiry : 1800-888-111
- ⚠ Some residual water used during post-manufacturing inspection may be present in the filter.
- ⚠ Do not reuse the previously used tap water supply valve and hose when installing the water purifier.

HOW TO CLEAN

How to Clean Internal Water Tank

1. Close the tap water supply valve, then use the drain hose to completely drain all water from inside the water purifier. When drainage is complete, unplug the power.

- * Use the drain hose and cold/room-temperature water dispensing faucet to completely drain all water from inside the water purifier.
- * Drain water in the cold/room-temperature water tanks through the cold/room-temperature water faucets and water in the hot water tank (CHP-6310L) through the side drain.

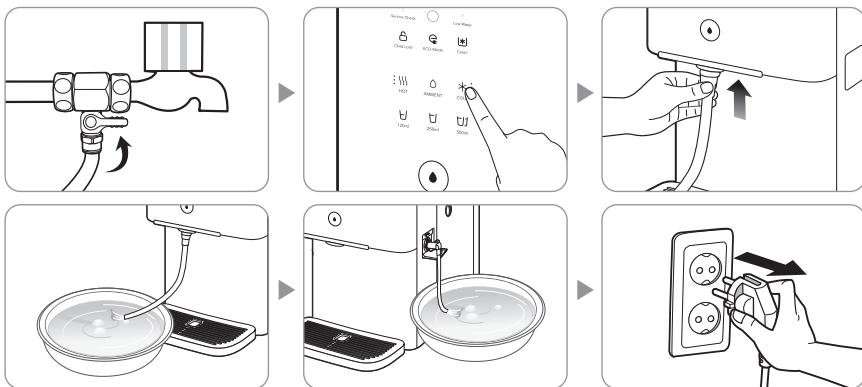

2. Push the top cover of the purifier upward to open.

Open the 6 clips affixing the interior storage tank and then open the internal water tank cover.

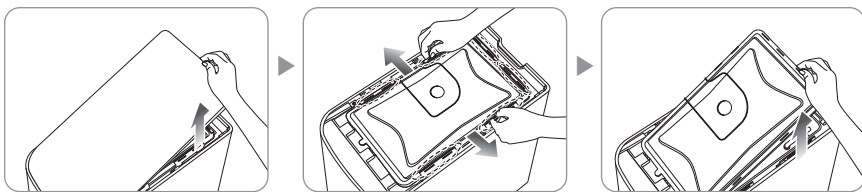

3. Detach the antibacterial filter from the water tank cover and shake in purified water to clean, then reinstall. Replace with a new part every 12 months.

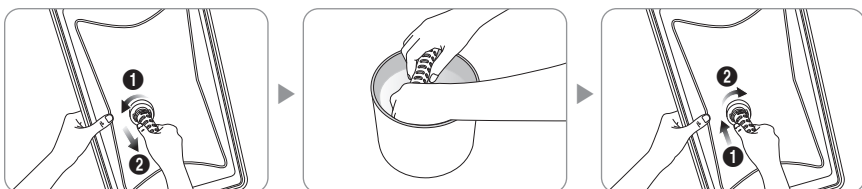

4. Wipe the water tank surfaces with a soft cloth.

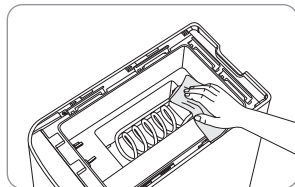

5. Rinse the internal water tank clean with water from the water purifier, then plug in the power again and completely drain it using the continuous dispensing button. Empty newly purified water once more before use.

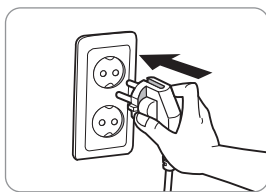
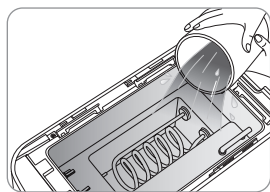

6. Install the separator, then press firmly at both ends so it stays in place.

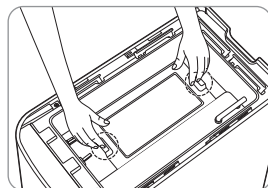
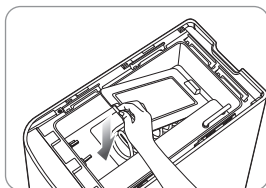

7. Close the top cover and open the water supply valve, then restart the water purifier.

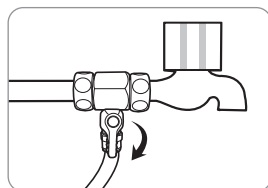
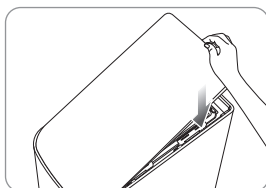

Tips

- ⚠ Please shut the internal water tank cover completely. Otherwise insects and debris may enter the product.
- ⚠ Do not use chemicals or detergent when cleaning the water tank. Residual chemicals and detergents may be harmful to the body.
- Please maintain a clean surrounding area and clean the internal water tank once every two months.

HOW TO CLEAN

How to Clean the Tray

1. How to remove the tray

The front of the tray can be easily separated by pulling the front of it. Separate the tray and wipe the inside and outside with a cloth.

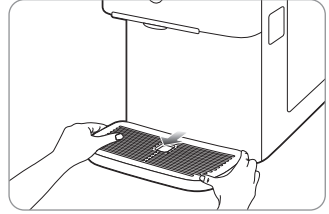

2. How to assemble the tray

Attach the tray hooks to the water purifier and then gently push.

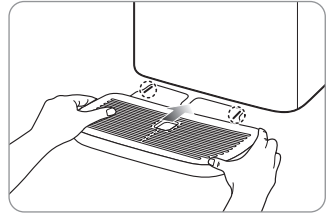

How to Clean the Water Purifier

Wipe the product with a clean towel.

* For thicker layers of dust, use a wet towel to wipe (Do not use an abrasive).

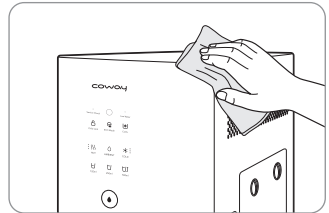

Tips

- Do not immerse the product in water to clean it.
- Do not use thinner, benzene or agent containing abrasives or rough cloths to clean it.

How to Clean the Transparent Faucet Cover

1. Detach the transparent faucet cover by pulling it outward.

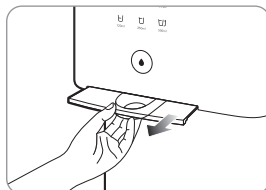

2. Rinse the transparent faucet cover with water.



3. After rinsing, wipe the transparent faucet cover with a soft, dry cloth.

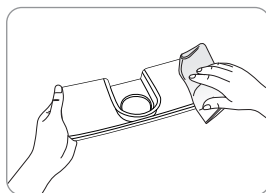

4. After cleaning, attach the transparent faucet cover back by pushing it inwards.

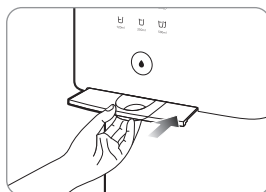

Tips

⚠ Never clean using cotton balls. Foreign matter such as cotton may be left behind.

FILTER REPLACEMENT

Filter Replacement

■ Filter

The life of a water purifier is its filters. Using an uncertified filter; or even using a certified yet expired filter may reduce filter performance.

Replace with authorized filters according to the replacement cycle.

A Coway Cody will visit to replace the filters.

*** Call 1800-888-111 for filter replacement.**

■ Filter replacement cycle

If the filter is not regularly replaced, it may degrade the water quality from the product.

The filter change cycle may vary within the range of expected replacement cycle depending on the source water quality.

CHP/CP-6310L

Filter name	Recommended replacement cycle
Neo-sense filter	6 months
Membrane filter (RO)	24 months
Plus Inno-sense filter	18 months

■ About the filter replacement cycle

Each filter's recommended replacement cycle is calculated based on water supply quality.

For reference, the effective water capacity means the minimum treatment capacity for which contaminants can be effectively removed without cleaning, recycling, or replacing the inner filters, and recommended replacement cycles for individual filters may differ.

HOW TO REPLACE THE FILTER

Replace the Filter!

1. Lock the water supply valve and completely drain all water from inside the filtration device.

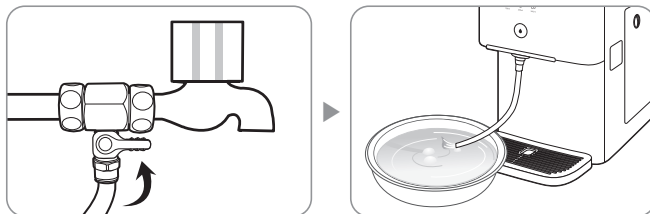

2. Turn the door handle of the right top cover to remove the side cover.

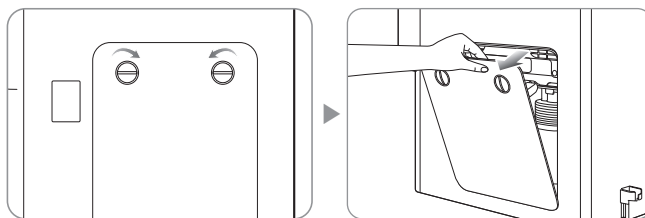

Tips

⚠ After replacing the filter, connect fittings and hoses precisely and check that there are no leaks. Be sure to first drain purified water.

HOW TO REPLACE THE FILTER

3. Hold the bottom of the filter you want to replace with one hand and raise the lock lever upward to replace the filter.

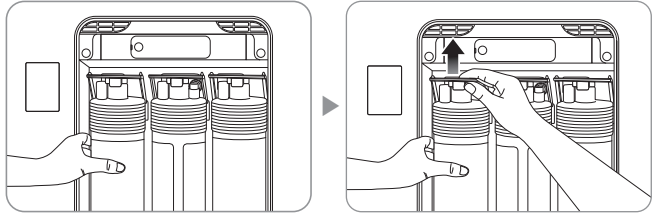

Tips

⚠ Check that the filter is securely installed and that the lever is supporting it well, then turn on the source water to check that there are no leaks.

4. Close the cover and turn the lever located to the right of the cover toward the outside to lock it, then insert the side door into the slot. (If you do not turn the lever to close the door, it will not be closed.)

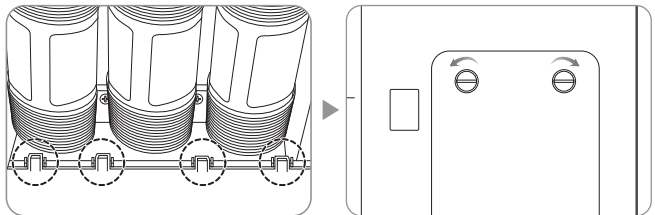

Tips

⚠ Please be sure to use the new filter after flushing.

- Neo-sense filter : Please assemble after flushing with tap water for 1 minute.
- Plus Inno-sense filter : Please use the filter without flushing.
- Membrane filter (RO) : Please assemble after flushing with Neo-sense filter for about 5 minutes.



Tips

We will replace fittings, tubings, and faucets after 5 years of use if you contact our customer service center (this may incur a cost).

REGULAR MAINTENANCE

Regular Maintenance

To use your device safely, it's best to perform occasional maintenance.
Check the following occasionally so your device is always working to its full potential.

■ Power

- Does the display go from on to off if you move the power cord while it is connected?
- Is part of the power cord warmer than usual?
- Is part of the power cord warped, discolored, or damaged?

 If these problems occur, immediately stop using the device and contact a service center. (1800-888-111)

■ Display

- Are the indicators on the front panel flashing abnormally?

If indicators flash abnormally, contact a service center immediately. (1800-888-111)

TROUBLESHOOTING

The water purifier may operate abnormally because the user is unfamiliar with the product or due to some other reasons and not because of a product malfunction. In such a case, problems can be easily solved without help from the service center by checking the following. If the problem is not solved after checking the following, please call the service center.

Problem	Check	Possible Solutions
The water has a poor aftertaste.	• Have you cleaned the water tank?	Clean the water tank.
	• The water filtration device has not been used for a very long time.	Discard stored water and clean the water tank.
	• Is it time to replace a filter?	Request a filter replacement.
Water doesn't come out.	• Is the water supply cut off or is the connection valve locked?	Open the connection valve.
	• Is it past time to replace a filter?	Request a filter replacement.
The quantity of room-temperature water has suddenly decreased.	• Is it time to replace a filter?	Request a filter replacement.
	• Is the power connected?	Check that the power cord is plugged into a 220 V 240 V~ 50Hz socket.
	• Is the connection valve locked?	Open the connection valve.
	• Did the temperature of the source water suddenly drop?	If the water temperature drops, the quantity of room-temperature water decreases.
Cold water doesn't come out.	• Is the cold water indicator lit?	Press the cold water button to turn on cold water.
	• Is the connection valve locked?	The cooler does not operate if the water level is low. This is to protect the motor. Open the connection valve.
	• Is the back of the device too close to a wall?	Keep a distance of at least 10 cm between the back of the device and the wall.
Hot water doesn't come out (CHP-6310L).	• Is the hot water indicator lit?	Press the hot water button to turn on hot water.
	• Is the PowerSave indicator lit?	Water may be less hot than usual while in PowerSave mode.
	• Is the connection valve locked?	The heater does not operate if the water level is low. This is to protect the motor. Open the connection valve.
The device was working, and then suddenly stopped.	• Is the source water supply good?	Check the connection valve.
	• Is the power connected?	Check that the power cord is plugged into a 220 V 240 V~ 50Hz socket.
	• Is water overflowing or leaking?	Request service.

► Filter replacement, service inquiries : 1800-888-111

SPECIFICATIONS

Product name		Coway Water Purifier/ electric water cooler (and hot water heater)	Coway Water Purifier/ electric water cooler
Model name		CHP-6310L	CP-6310L
Filtration method		Reverse osmosis	
Collection rate		50 % (343 kPa, 25 °C, NaCl 200 ppm)	
Rated voltage		220 V -240 V~ 50 Hz	
Rated input		Cold water : 0.5 A, Hot water : 250 W - 300 W	Cold water : 0.5 A
Display information		Water temperature display, locking feature	Water temperature display
Main functions		Room-temperature water, cold water, hot water, overheating/overcooling prevention, set quantity dispensing, continuous dispensing	Room-temperature water, cold water, overcooling prevention, set quantity dispensing, continuous dispensing
Water tank capacity	Room-temperature water	2.5 L	2.5 L
	Cold water	2.5 L	2.5 L
	Hot water (CHP-6310L)	1.0 L	-
	Total	6.0 L	5.0 L
Filter material	Neo-sense filter (Carbon block pre-filter)	Block activated carbon	
	Membrane filter (RO)	Reverse osmosis filter	
	Plus Inno-sense filter (Carbon block post-filter)	Block activated carbon, non-woven fabric	
Product size		260 mm (width) x 483 mm (depth) x 510 mm (height)	
Operating temperature		5 °C - 35 °C	
Operating temperature		5 °C - 35 °C	
Effective water capacity		680 L (for VOC, reduction of substances certified to NSF/ANSI 401) 11 000 L (for Aesthetic Chlorine)	
Operating pressure (tap water)		1.4 MPa - 0.83 MPa	
Net weight		17.3 kg	16.3 kg

- ▶ The water tank capacity may differ slightly from the quantity of obtainable water due to the size of the water tank.
- ▶ Product design and specifications are regulated by law and are subject to change without notice to improve the product or its quality.
- ▶ Collection rate refers to the amount of water that comes out compared to the amount that goes in.
- ▶ May differ depending on the installation location water pressure, water temperature, and water quality.

WATER FLOW DIAGRAM

CHP-6310L

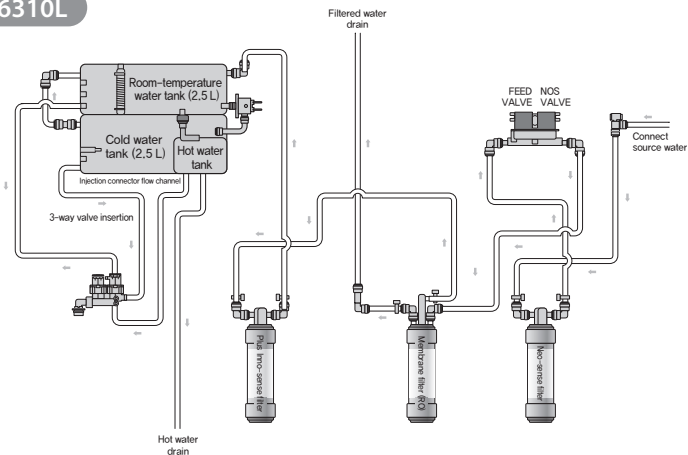

CP-6310L

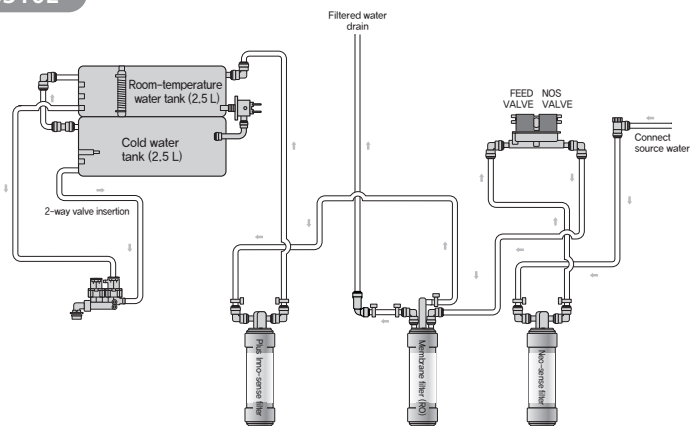

Water Filtration System Performance Data Sheet



Model: CHP-6310L(MY)

This system has been tested and certified by the Water Quality Association according to NSF/ANSI 42, 53, 58. The concentration of the indicated substances in water entering the system was reduced to a concentration less than or equal to the permissible limit for water leaving the system, as specified in NSF/ANSI 42, 53, 58.

Substance	Influent challenge Concentration (mg/L unless specified)	Maximum permissible Product water Concentration (mg/L unless specified)	Percent Reduction (%)
Arsenic (Pentavalent)	0.050 ± 10%	0.01	97.8
Barium	10.0 ± 10%	2	97.2
Radim 226/228	25 pCi/L	5 pCi/L	80
Cadmium	0.03 ± 10%	0.005	98.2
Chromium (Hexavalent)	0.3 ± 10%	0.1	98.6
Chromium (Trivalent)	0.3 ± 10%	0.1	99.4
Copper	3.0 ± 10%	1.3	98.1
Lead	0.15 ± 10%	0.01	99.1
Selenium	0.10 ± 10%	0.05	98.3
TDS	750 ± 40	187	89.9
Aesthetic Chlorine	2.0 ± 10%	≥ 50% Reduction	72.8
VOC*	0.300 ± 10%	≥ 95% Reduction	99.4
Cyst	Minimum 50 000/L	0.9995	99.99

While testing was performed under standard laboratory conditions, actual performance may vary.

General Operating Information:

Daily production Rate	152.6 L/day
Rated Capacity	680 L (for VOC) 11 000 L (for Aesthetic Chlorine)
Min-Max operating pressure:	1.4 MPa ~ 0.83 MPa
Min-Max operating temperature:	5 °C ~ 35 °C
Rated Service Flow	0.26 L/min
Electrical Requirement	Refer to rating plate

- Do not use with water that is microbiologically unsafe or of unknown quality without adequate disinfection before or after the system.
- Systems certified for cyst reduction may be used on disinfected waters that may contain filterable cysts.
- The estimated replacement time of filter, which is a consumable part, is not an indication of quality guarantee period, but it means the ideal time of filter replacement. Accordingly, the estimated time of filter replacement may be shortened in case it is used in an area of poor water quality.
- The filtration device installation shall comply with applicable state and local regulations.

- The reverse osmosis system contains a replaceable treatment component, critical for the effective reduction of total dissolved solids and that product water shall be tested periodically to verify that the system is performing properly
- The influent water to the system shall include the following characteristics:
 - o No organic solvents
 - o Chlorine: < 2 ppm
 - o pH: 7 - 8
 - o Temperature: 41 °F ~ 95 °F (5 °C ~ 35 °C)
 - o Iron: < 2 mg/L
 - o Turbidity: < 1 NTU
 - o Hardness: < 1000 mg/L
- This system has been tested for the treatment of water containing pentavalent arsenic (also known as As(V), As(+5), or arsenate) at concentrations of 0.050 mg/L or less. This system reduces pentavalent arsenic, but may not remove other forms of arsenic. This system is to be used on water supplies containing a detectable free chlorine residual at the system inlet or on water supplies that have been demonstrated to contain only pentavalent arsenic. Treatment with chloramines (combined chlorine) is not sufficient to ensure complete conversion of trivalent arsenic to pentavalent arsenic. Please see the Arsenic Facts section of this Performance Data Sheet for further information.
- Efficiency rating means the percentage of the influent water to the system that is available to the user as reverse osmosis treated water under operating conditions that approximate typical daily usage.
- Refer to the owner's manual for specific installation instructions, manufacturer's limited warranty, user responsibility, and parts and service availability.
- For parts and service availability, please contact your local dealer or Coway.

Model of Filter	Type	Usable period (Months)
CNFN8S	NEO-SENSE FILTER	6
CRMFN8S-20-N2	RO MEMBRANE FILTER	24
CIFN8S-PLUS	PLUS INNONSENSE FILTER	18

ARSENIC FACTS

Arsenic (abbreviated As) is found naturally in some well water. Arsenic in water has no color, taste or odor. It must be measured by a lab test. Public water utilities must have their water tested for arsenic. You can get the results from your water utility. If you have your own well, you can have the water tested. The local health department or the state environmental health agency can provide a list of certified labs. The cost is typically \$15 to \$30. Information about arsenic in water can be found on the Internet at the US Environmental Protection Agency website: www.epa.gov/safewater/arsenic.html

There are two forms of arsenic: pentavalent arsenic (also called As(V), As(+5), and arsenate) and trivalent arsenic (also called As(III), As(+3), and arsenite). In well water, arsenic may be pentavalent, trivalent, or a combination of both. Special sampling procedures are needed for a lab to determine what type and how much of each type of arsenic is in the water. Check with the labs in your area to see if they can provide this type of service.

Reverse osmosis (RO) water treatment systems do not remove trivalent arsenic from water very well. RO systems are very effective at removing pentavalent arsenic. A free chlorine residual will rapidly convert trivalent arsenic to pentavalent arsenic. Other water treatment chemicals such as ozone and potassium permanganate will also change trivalent arsenic to pentavalent arsenic. A combined chlorine residual (also called chloramine) may not convert all the trivalent arsenic. If you get your water from a public water utility, contact the utility to find out if free chlorine or combined chlorine is used in the water system.

The CHP-6310L and CP-6310L system is designed to remove pentavalent arsenic. It will not convert trivalent arsenic to pentavalent arsenic. The system was tested in a lab. Under those conditions, the system reduced 0.050 mg/L pentavalent arsenic to 0.010 mg/L (ppm) (the USEPA standard for drinking water) or less. The performance of the system may be different at your installation. Have the treated water tested for arsenic to check if the system is working properly. The RO component of the CHP-6310L and CP-6310L system must be replaced every 20 months to ensure the system will continue to remove pentavalent arsenic. The component identification and locations where you can purchase the component are listed in the installation/operation manual.

* VOC Surrogate Claims

Chemical	Drinking water regulatory level ¹ (MCL/MAC)mg/L	Influent challenge concentration ² mg/L	Chemical reduction percent	Maximum product water concentration mg/L
alachlor	0.002	0.050	> 98	0.001 ³
atrazine	0.003	0.100	> 97	0.003 ³
benzene	0.005	0.081	> 99	0.001 ³
carbofuran	0.04	0.190	> 99	0.001 ³
carbon tetrachloride	0.005	0.078	98	0.0018 ⁴
chlorobenzene	0.1	0.077	> 99	0.001 ³
chloropicrin	-	0.015	99	0.0002 ³
2,4-D	0.07	0.110	98	0.0017 ⁴
dibromochloropropane(DBCP)	0.0002	0.052	> 99	0.00002 ³
o-dichlorobenzene	0.6	0.080	> 99	0.001 ³
p-dichlorobenzene	0.075	0.040	> 98	0.001 ³
1,2-dichloroethane	0.005	0.088	95 ⁵	0.0048 ⁵
1,1-dichloroethylene	0.007	0.083	> 99	0.001 ³
cis-1,2-dichloroethylene	0.07	0.170	> 99	0.0005 ³
trans-1,2-dichloroethylene	0.1	0.086	> 99	0.001 ³
1,2-dichloropropane	0.005	0.080	> 99	0.001 ³
cis-1,3-dichloropropylene	-	0.079	> 99	0.001 ³
dinoseb	0.007	0.170	99	0.0002 ⁴
endrin	0.002	0.053	99	0.00059 ⁴
ethylbenzene	0.7	0.088	> 99	0.001 ³
ethylene dibromide (EDB)	0.00005	0.044	> 99	0.00002 ³
haloacetonitriles (HAN)				
bromochloroacetonitrile	-	0.022	98	0.0005 ³
dibromoacetonitrile	-	0.024	98	0.0006 ³
dichloroacetonitrile	-	0.0096	98	0.0002 ³
trichloroacetonitrile	-	0.015	98	0.0003 ³
haloketones (HK):				
1,1-dichloro-2-propanone	-	0.0072	99	0.0001 ³
1,1,1-trichloro-2-propanone	-	0.0082	96	0.0003 ³
heptachlor (H-34,Heptox)	0.0004	0.08	> 99	0.0004
heptachlor epoxide	0.0002	0.0107 ⁶	98	0.0002 ⁶
hexachlorbutadiene	-	0.044	> 98	0.001 ³
hexachlorocyclopentadiene	0.05	0.060	> 99	0.000002 ³
lindane	0.0002	0.055	> 99	0.00001 ³
methoxychlor	0.04	0.050	> 99	0.0001 ³
pentachlorophenol	0.001	0.096	> 99	0.001 ³
simazine	0.004	0.120	> 97	0.004 ³
styrene	0.1	0.150	> 99	0.0005 ³
1,1,2,2-tetrachloroethane	-	0.081	> 99	0.001 ³
tetrachloroethylene	0.005	0.081	> 99	0.001 ³
toluene	1	0.078	> 99	0.001 ³
2,4,5-TP (silvex)	0.05	0.270	99	0.0016 ⁴
tribromoacetic acid	-	0.042	> 98	0.001 ³
1,2,4-trichlorobenzene	0.07	0.160	> 99	0.0005 ³
1,1,1-trichloroethane	0.2	0.084	95	0.0046 ⁴
1,1,2-trichloroethane	0.005	0.150	> 99	0.0005 ³
trichloroethylene	0.005	0.180	> 99	0.0010 ³
trihalomethanes (includes):				
chloroform (surrogate chemical)				
bromoform				
bromodichloromethane				
chlorodibromomethane	0.080	0.300	95	0.015
xylenes (total)	10	0.070	> 99	0.001 ³

¹ These harmonized values were agreed upon by representatives of USEPA and Health Canada for the purpose of evaluating products to the requirements of this Standard.

² Influent challenge levels are average influent concentrations determined in surrogate qualification testing.

³ Maximum product water level was not observed but was set at the detection limit of the analysis.

⁴ maximum product water level is set at a value determined in surrogate qualification testing.

⁵ Chemical reduction percent and maximum product water level calculated at chloroform 95% breakthrough point as determined in surrogate qualification testing.

⁶ The surrogate test results for heptachlor epoxide demonstrated a 98% reduction. These data were used to calculate an upper occurrence concentration which would produce a maximum product water level at the MCL.

MEMO



MEMO

coway

www.coway.com

